

THEORY & OBJECTIVE

BASIC ELECTRONICS

*By
Team of
Engineers Academy*

- State Engineering Services Examinations.
- Public Sector Examinations.
- JEn (SSC, DMRC & State Level).
- Other Technical Competitive Exams.



ENGINEERS ACADEMY[®]

Your GATEway to Professional Excellence

IES • GATE • PSUs • JTO • IAS • NET

CORPORATE OFFICE

100-102, Ram Nagar, Bambala Puliya, Tonk Road, Pratap Nagar, Jaipur-302033

Ph.: + 91-8094441777

Website : www.engineersacademy.org | Email: info@engineersacademy.org

Ajmer | Jaipur | Kota | Jodhpur | Bhilwara | Delhi | Patna | Lucknow | LPU | Ludhiana | Jalandhar | Kanpur | Allahabad

CONTENTS

S.No.	Topic	Page No.
1.	Semiconductor Diodes	1 – 24
	Practice Sheet.....	25 – 35
2.	Bipolar Junction Transistor	36 – 50
	Practice Sheet.....	51 – 60
3.	Field Effect Transistors	61 – 67
	Practice Sheet.....	68 – 71
4.	Miscellaneous	72 – 85
	Practice Sheet.....	86 – 95



SEMICONDUCTOR DIODES

THEORY

1.1 SEMICONDUCTOR PHYSICS

1.1.1 Energy Bands

In gaseous substances, the arrangement of molecules is not close. In liquids, the molecular arrangement is moderate. But, in solids, the molecules are so closely arranged, that the electrons in the atoms of molecules tend to move into the orbitals of neighbouring atoms. Hence the electron orbital's overlap when the atoms come together.

Due to the intermixing of atoms in solids, instead of single energy levels, there will be bands of energy levels formed. These set of energy levels, which are closely packed are called as Energy bands.

(i) **Valance Band:** The electrons move in the atoms in certain energy levels but the energy of the electrons in the innermost shell is higher than the outermost shell electrons. The electrons that are present in the outermost shell are called as valance electrons. These valance electrons, containing a series of energy levels, form an energy band which is called as valance band. The valance band is the band having the highest occupied energy.

(ii) **Conduction Band:** The valence electrons are so loosely attached to the nucleus that even at room temperature; few of the valence electrons leave the band to be free. These are called as free electrons as they tend to move towards the neighbouring atoms. These free electrons are the ones which conduct the current in a conductor and hence called as conduction electrons. The band which contains conduction electrons is called as conduction band. The conduction band is the band having the lowest occupied energy.

(iii) **Forbidden gap:** The gap between valence band and conduction band is called as forbidden energy gap. As the name implies, this band is the forbidden one without energy. Hence no electron stays in this band. The valence electrons, while going to the conduction band, pass through this.

The following figure shows the valance band, conduction band, and the forbidden gap.

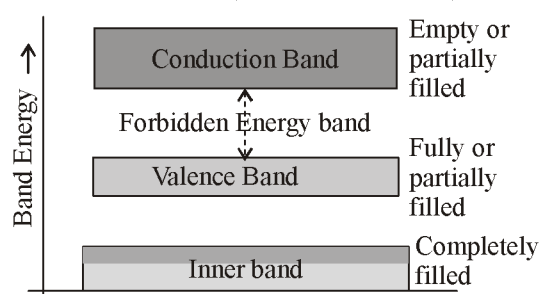

Depending upon the size of the forbidden gap, the Insulators, the Semiconductors and the Conductors are formed.

(a) Insulators: Insulators are such materials in which the conduction cannot take place, due to the large forbidden gap.

Ex. : Wood, Rubber.

The structure of energy bands in Insulators is as shown in the following figure.

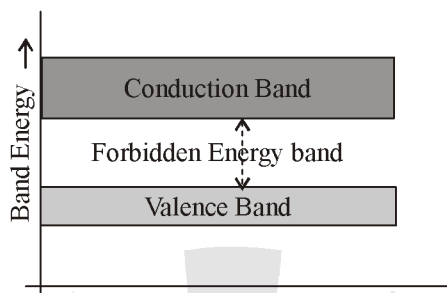

Characteristics: The following are the characteristics of Insulators.

- The Forbidden energy gap is very large.
- Valence band electrons are bound tightly to atoms.
- The value of forbidden energy gap for an insulator will be of 6 eV.
- For some insulators, as the temperature increases, they might show some conduction.
- The resistivity of an insulator will be in the order of 10^7 ohmmeter.

(b) Semiconductors: Semiconductors are such materials in which the forbidden energy gap is small and the conduction takes place if some external energy is applied.

Ex. : Silicon, Germanium.

The following figure shows the structure of energy bands in semiconductors.

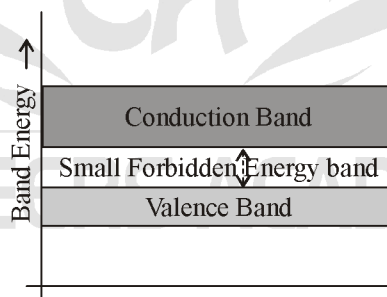

Characteristics: The following are the characteristics of Semiconductors.

- The Forbidden energy gap is very small.
- The forbidden gap for Ge is 0.7eV whereas for Si is 1.1 eV.
- A Semiconductor actually is neither an insulator, nor a good conductor.
- As the temperature increases, the conductivity of a semiconductor increases.
- The conductivity of a semiconductor will be in the order of 10^2 mhometer.

Semiconductor	Band Gap (eV)
Silicon (Si)	1.1
Germanium (Ge)	0.66
Germanium Arsenide (GaAs)	1.41
Indium Phosphate (InP)	1.34
Zinc tellurite (Zn Te)	2.26
Cudmium Tellurite (CdTe)	1.43

(c) **Conductors** : Conductors are such materials in which the forbidden energy gap disappears as the valence band and conduction band become very close that they overlap.

Ex. : Copper, Aluminium.

The following figure shows the structure of energy bands in conductors.

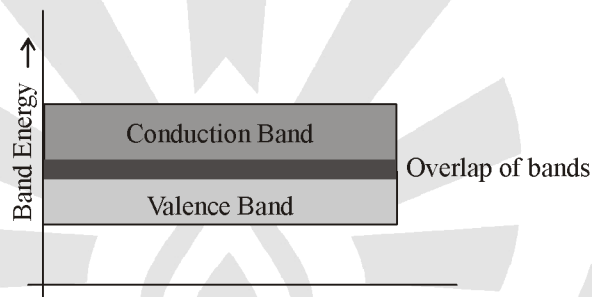

Characteristics : The following are the characteristics of Conductors.

- There exists no forbidden gap in a conductor.
- The valence band and the conduction band gets overlapped.
- The free electrons available for conduction are plenty.
- A slight increase in voltage, increases the conduction.
- There is no concept of hole formation, as a continuous flow of electrons contribute the current.

1.1.2 Fermi Level

Fermi energy is expressed in eV. Fermi energy is defined as the maximum energy possessed by an electron at 0 K.

Fermi energy is defined as the maximum kinetic energy possessed by an electron at 0 K.

$$\text{Max. KE} = \frac{1}{2} m V_{\text{max}}^2$$

$$E_F = \frac{1}{2} m V_{\text{max}}^2$$

$$\text{Max. velocity of } e^- = V_{\text{max}} = \sqrt{\frac{2E_F}{m}} \text{ m/sec}$$

Fermi energy is also defined as the energy possessed by fastest moving e^- electron at 0 K.

1.1.3 Types of Semiconductors

(i) Intrinsic Semiconductors : Also called pure semiconductor (or) non-degenerative semiconductor (as basic properties are not changed). Degenerate means change of basic properties by adding impurity. Hence extrinsic semiconductor is known as degenerate semiconductor.

The properties of this pure semiconductor are as follows

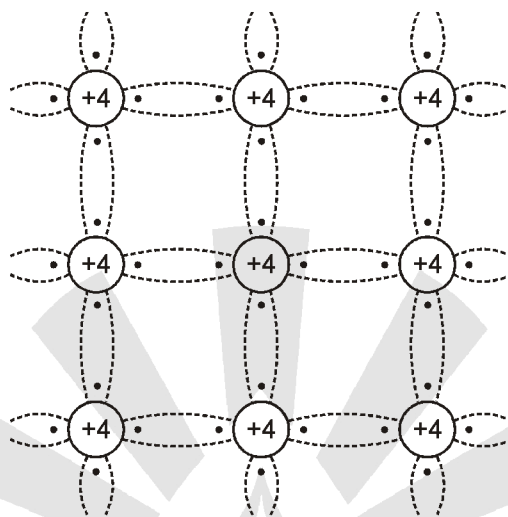

Intrinsic SC at T = 0 K

- The electrons and holes are solely created by thermal excitation.
- The number of free electrons is equal to the number of holes.
- The conduction capability is small at room temperature.
- Intrinsic semiconductor behaves as a perfect insulator at 0 K.
- The sharing of electrons with neighbouring atom is called covalent bonding.
- At 0 K all valence electrons are in perfect covalent bonding.
- Intrinsic semiconductor at 0 K is a perfect insulator.
- Fermi level is middle to valance band and conduction band.

In order to increase the conduction capability of intrinsic semiconductor, it is better to add some impurities. This process of adding impurities is called as Doping. Now, this doped intrinsic semiconductor is called as an Extrinsic Semiconductor.

Doping : The process of adding impurities to the semiconductor materials is termed as doping. The impurities added, are generally pentavalent and trivalent impurities.

Pentavalent Impurities : The pentavalent impurities are the ones which has five valence electrons in the outer most orbit.

Ex. : Bismuth, Antimony, Arsenic, Phosphorus

The pentavalent atom is called as a donor atom because it donates one electron to the conduction band of pure semiconductor atom.

Trivalent Impurities: The trivalent impurities are the ones which has three valence electrons in the outer most orbit.

Ex. : Gallium, Indium, Aluminum, Boron

The trivalent atom is called as an acceptor atom because it accepts one electron from the semiconductor atom.

(ii) Extrinsic Semiconductor : An impure semiconductor, which is formed by doping a pure semiconductor is called as an extrinsic semiconductor. It is also called impurity semiconductor (or) doped semiconductors (or) artificial semiconductors (or) de-generate semiconductor or compensated semiconductor. There are two types of extrinsic semiconductors depending upon the type of impurity added. They are N-type extrinsic semiconductor and P-Type extrinsic semiconductor.

(a) N-Type Extrinsic Semiconductor : A small amount of pentavalent impurity is added to a pure semiconductor to result in N-type extrinsic Semiconductor. The added impurity has 5 valence electrons. For example, if pentavalent atom is added to the semiconductor atom, four of the valence electrons get attached with the Ge atoms while one electron remains as a free electron. This is as shown in the following figure.

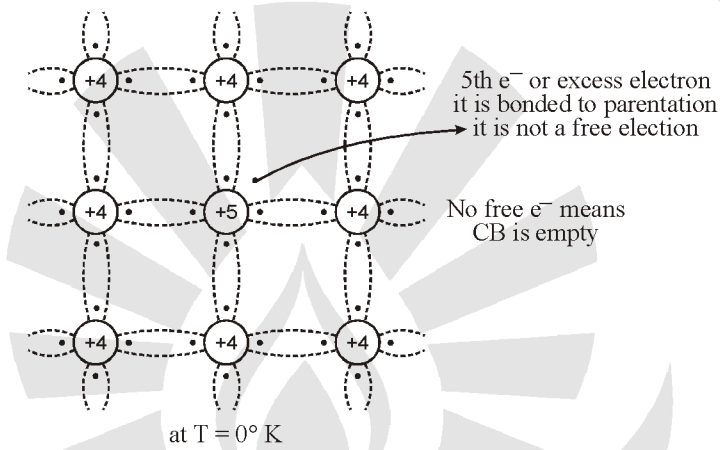

All of these free electrons constitute electron current. Hence, the impurity when added to pure semiconductor, provides electrons for conduction.

- In N-type extrinsic semiconductor, as the conduction takes place through electrons, the electrons are majority carriers and the holes are minority carriers.
- As there is no addition of positive or negative charges, the electrons are electrically neutral.
- When an electric field is applied to an N-type semiconductor, to which a pentavalent impurity is added, the free electrons travel towards positive electrode. This is called as negative or N-type conductivity.
- The minimum energy required to conduction in N-Type Ge is 0.01 eV.
- The minimum energy required to conduction in N-Type Si is 0.05 eV.
- N-Type semiconductor at 0 K is a perfect insulator.
- Fermi level is near to conduction band.

(b) P-Type Extrinsic Semiconductor : A small amount of trivalent impurity is added to a pure semiconductor to result in P-type extrinsic semiconductor. The added impurity has 3 valence electrons. For example, if trivalent atom is added to the semiconductor atom, three of the valence electrons get attached with the semiconductor atoms, to form three covalent bonds. But, one more electron in semiconductor remains without forming any bond. As there is no electron in trivalent atom remaining to form a covalent bond, the space is treated as a hole. This is as shown in the following figure.

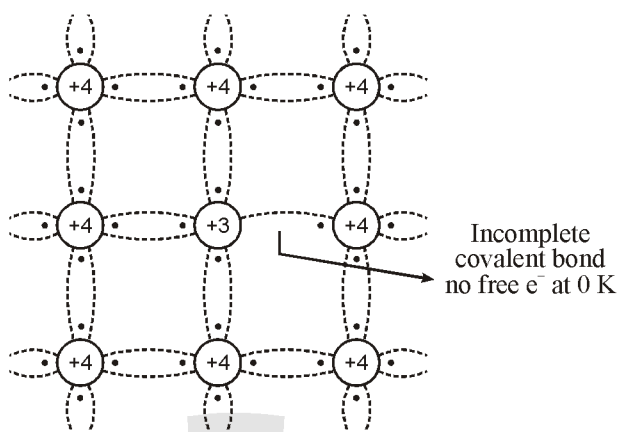

The boron impurity when added in a small amount, provides a number of holes which helps in the conduction. All of these holes constitute hole current.

- In P-type extrinsic semiconductor, as the conduction takes place through holes, the holes are majority carriers while the electrons are minority carriers.
- The impurity added here provides holes which are called as acceptors, because they accept electrons from the germanium atoms.
- As the number of mobile holes remains equal to the number of acceptors, the P-type semiconductor remains electrically neutral.
- When an electric field is applied to a P-type semiconductor, to which a trivalent impurity is added, the holes travel towards negative electrode, but with a slow pace than electrons. This is called as P-type conductivity. In this P-type conductivity, the valence electrons move from one covalent bond to another, unlike N-type.
- The minimum energy required to conduction in P-Type Ge is 0.01 eV.
- The minimum energy required to conduction in P-Type Si is 0.05 eV.
- P-Type semiconductor at 0 K is a perfect insulator.
- Fermi level is near to valance band.

Note:

Why Silicon is Preferred in Semiconductors?

Among the semiconductor materials like germanium and silicon, the extensively used material for manufacturing various electronic components is Silicon. Silicon is preferred over germanium for many reasons such as

- The energy band gap is 0.7 eV, whereas it is 0.2 eV for germanium.
- The thermal pair generation is smaller.
- The formation of SiO₂ layer is easy for silicon, which helps in the manufacture of many components along with integration technology.
- Si is easily found in nature than Ge.
- Noise is less in components made up of Si than in Ge.

1.1.4 Mass-Action Law

In a semiconductor (intrinsic and extrinsic) under thermal equilibrium the product of e^- holes is always a constant and is equal to the square of intrinsic concentration.

$$n \cdot p = n_i^2$$

where n = concentration of e^-
 p = concentration of holes
 n_i = intrinsic concentration

(i) For N-type semiconductor

Mass-action law is given by

$$n_n p_n = n_i^2$$

where n_n = concentration of e^-
 p_n = concentration of holes

For n-type materials concentration of e^- is almost equal to the donor concentration.

$\therefore n_n \approx N_D$

$$N_D p_n = n_i^2$$

$$p_n = \frac{n_i^2}{N_D}$$

(ii) For p-type semiconductor

Mass action law is given by

$$n_p p_p = n_i^2$$

where n_p = concentration of e^-
 p_p = concentration of holes

For p-type materials concentration of e^- is almost equal to the acceptor concentration

$$p_p \approx N_A$$

$$N_p \cdot N_A = n_i^2$$

$$N_p = \frac{n_i^2}{N_A}$$

1.1.5 Direct and Indirect Band gap semiconductors

(i) **Direct Band-Gap semiconductor** : In this type of semiconductor electrons from excited state in conduction band jump directly to valence band.

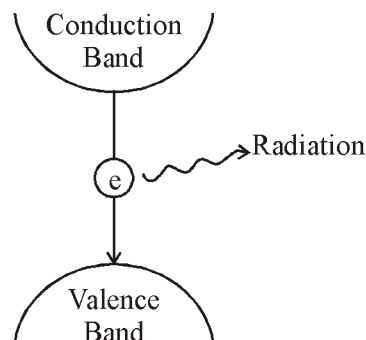

While jumping from conduction band to valence band the electron loose an energy, equal to the band gap in the form of radiation.

$$h\nu = E_G$$

where h = plank constant = 6.626×10^{-34} JS
 ν = frequency of radiation

$$\nu = \frac{c}{\lambda}$$

where c = velocity of light = 3×10^8 m/s
 λ = wave length

$$\frac{hc}{\lambda} = E_G$$

$$\lambda = \frac{hc}{E_G} \Rightarrow \lambda = \frac{1.24}{E_G} \mu\text{m}$$

where λ in μm and E_G in eV.

Ex. : GaAs

Note : In this most of the falling e^- from conduction band to valence band will be directly releasing energy in form of light (99%) and very few e^- while falling from conduction band to valence band will collide with the crystal of atoms and these crystal will be absorbing the energy from the falling electrons and gets heated up and they will release energy in form of heat (1%).

(ii) Indirect Band-Gap : The semiconductor in which electrons from conduction band do not jump directly to valence band rather first jump from conduction band to some intermediate energy level called defect level and then from intermediate energy level to valence band are called indirect band gap.

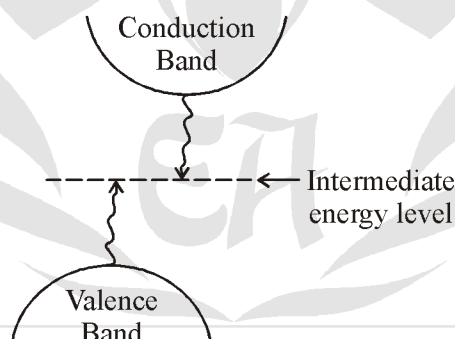

Ex. : Ge and Si

Note : In Indirect Band Gap semiconductor most of the falling electrons from conduction band to valence band will collide with the crystal of the atom and these crystal will be absorbing the energy from the falling electron and gets heated up and they will release energy in the form of heat (99%) and very few electrons falling on conduction band to valence band will directly falling and they will release energy in form of light (1%).

1.1.6 Einstein's Equation

It gives the relation between diffusion constant, mobility and thermal voltage.

$$\frac{D_n}{\mu_n} = \frac{D_p}{\mu_p} = \frac{KT}{q} = V_T = \frac{T}{11600}$$

Thermal voltage $V_T = \frac{KT}{q}$

1.1.7 Hall Effect

Hall effect states that : “If a specimen (metal or semiconductor) carrying the current I is placed in transverse magnetic field B , an electric field intensity E is induced in a direction perpendicular to both I and B ”.

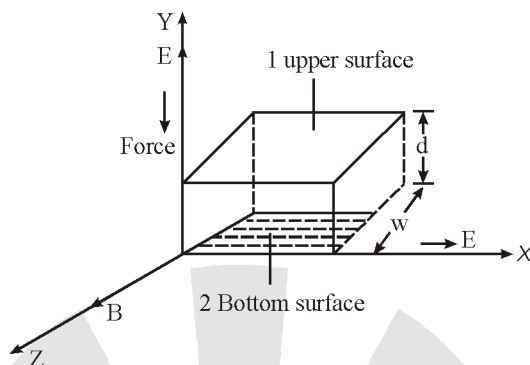

Where w is the width of specimen d is the height or thickness of the specimen (or) spacing between bottom surface and upper surface of specimen.

Representation of Hall voltage

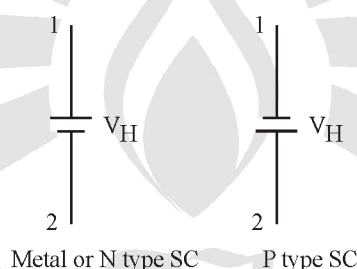

Hall effect can be used to determine :

- Whether the given specimen is a metal or semiconductor.
- The concentration of charge carrier in the specimen.
- Mobility of charge carrier.
- To measure the signal power in EM wave.
- In designing of hall effect transducer.

1.2 PN-JUNCTION

If we join a piece of P-type semiconductor to a piece of N-type semiconductor such that the crystal structure remains continuous at boundary. PN junction or diode as shown in figure.

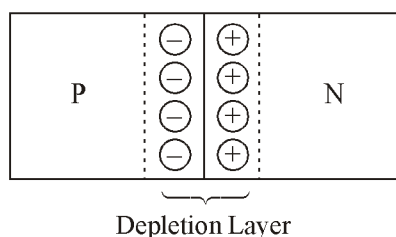

P-type region doped with acceptor type impurity have holes in majority and N-type region doped with donor type impurity have electrons in majority. When P-type and N-type piece are combined, electrons from N-side and holes from P-side diffused towards junction and disappear in the form of heat after neutralizing each other. In this process electrons from N-side and holes from P-side leaves the immobile positive and negative ions respectively. The region from where mobile charges have been depleted is called 'Depletion region'. Depletion region contains fixed rows of oppositely charged ions (immobile charge) on its two sides. These immobile opposite charges due to ions develops an electric potential. This potential is called barrier or junction potential V_B . Barrier potential is given by the relation :

$$V_B = V_T \ln \frac{N_A N_D}{n_i^2}$$

Where $V_T = \frac{T}{11600}$ (volt equivalent of temperature)

N_A = concentration of acceptors (/cm³) on P-side

N_D = concentration of donors (/cm³) on N-side

n_i = Intrinsic concentration (/cm³) at given temperature

$V_B = 0.3V$ for Ge }
 $V_B = 0.7V$ for Si } at room temperature

Built in potential in diode is given by :

$$V_B = V_T \ln \frac{N_A N_D}{n_i^2}$$

Applying voltage across a PN junction : The potential difference across a PN junction can be applied in two ways i.e. Reverse biasing and Forward biasing.

- (i) **Reverse Biasing :** In reverse biasing, P-side is connected to negative terminal of the battery and N-side is connected to positive terminal of the battery. This type of biasing increases the depletion width

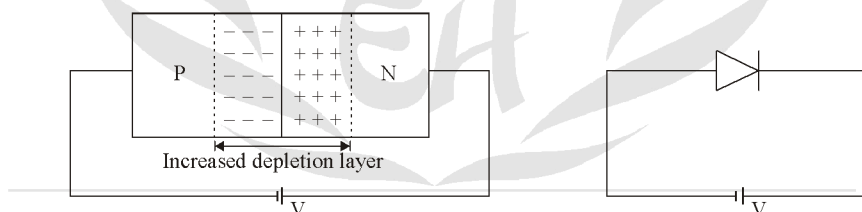

Only very small reverse saturation current flows which is truly temperature dependent. It does not depends on the amplitude of applied voltage.

Reverse saturation current or leakage current

$$I_0 = qA \left(\frac{D_P}{L_P N_D} + \frac{D_N}{L_N N_N} \right) n_i^2$$

$$I_0 \propto A$$

where, A = area of cross section

D_P, D_N = diffusion constant of holes and electrons respectively

L_P, L_N = diffusion length of holes and electrons respectively

Hence reverse saturation current is proportional to the area of junction.

Reverse Bias Diode has

- (i) High resistance
 - (ii) Very small reverse saturation current
 - (iii) Large depletion width.
- (ii) **Forward Biasing :** In forward biasing, P-side is connected to positive terminal of the battery and N-side connected to negative terminal of battery. The current through the diode is given by the relation.

$$I_D = I_0 \left(e^{\frac{V_D}{\eta V_T}} - 1 \right) \quad \dots(i)$$

Where,

- $\eta = 1$ for Ge
- $\eta = 2$ for Si for low current
- $\eta = 1$ for Si for high current

V_D = Voltage across diode

Equation (i) may also be written as :

$$\log I_D = \frac{I_0}{\eta} \times \frac{V_D}{V_T}$$

or

$$\log I_D \propto V_D$$

The characteristic between $\log I_D$ and voltage V_D has linear variation. This is shown in figure below :

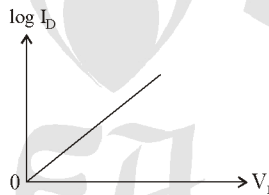

Characteristics of Forward Bias :

- (i) Very high current.
- (ii) Low resistance.
- (iii) Reduced depletion width.

Temperature dependency of I_0 and V_D :

- (i) The temperature and diode current in a PN junction diodes is related by the following relation:

$$I_{0(T_2)} = I_{0(T_1)} \times 2^{\frac{(T_2 - T_1)}{10}}$$

where, $I_{0(T_2)}$ = Reverse saturation current at temperature T_2

$I_{0(T_1)}$ = Reverse saturation current at temperature T_1

here $T_2 > T_1$

- (ii) Reverse saturation current doubles for each 10°C rise in temperature

$$\frac{dV_D}{dt} = -2.5 \text{ mV/}^\circ\text{C}$$

- (iii) Voltage across diode reduces by 25 mV for each 10°C increase in temperature.

PRACTICE SHEET

OBJECTIVE QUESTIONS

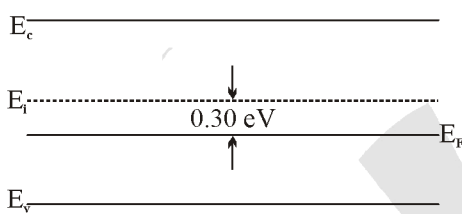
1. The energy band diagram for a uniformly doped Si sample maintained at $T = 300\text{ K}$ is shown in figure,
 $n_i = 10^{10}\text{ cm}^{-3}$

Semiconductor is

 - (a) lightly doped n type
 - (b) heavily doped n type
 - (c) lightly doped p type
 - (d) heavily doped p type
2. Pick the correct relation
 - (a) $n_i = A T^3 e^{-EG/KT}$
 - (b) $n_i^2 = A T^3 e^{-EG/KT}$
 - (c) $n_i = A T^{3/2} e^{-EG/KT}$
 - (d) $n_i^2 = A^2 T^3 e^{-EG/KT}$
3. Diffusion is associated with random motion of electrons or holes due to
 - (a) External applied electric field
 - (b) Concentration gradient of electrons or holes
 - (c) Thermal agitation
 - (d) (b) and (c) both
4. Electrons or holes are drifted in one direction due to
 - (a) External applied electric field
 - (b) Concentration gradient of electrons or holes
 - (c) Thermal agitation
 - (d) (b) and (c) both
5. The Hall angle θ of a metal sample is
 - (a) Independent of the magnetic flux density B
 - (b) Independent of the carrier mobility
 - (c) Independent of the density of free carriers
 - (d) Dependent on magnetic flux density, carrier mobility and density of free carriers
6. The hall effect voltage in intrinsic silicon is
 - (a) positive
 - (b) zero
 - (c) negative
 - (d) change sign on application of magnetic field
7. If the lattice temperature is increased, the Hall coefficient of a semiconductor will
 - (a) Decrease
 - (b) increases
 - (c) First increase to a peak and then decrease
 - (d) Remain constant
8. Graphite is a
 - (a) Conductor
 - (b) Insulator
 - (c) Semiconductor
 - (d) None of these
9. Doping is a process of
 - (a) purifying semiconductor material
 - (b) increasing impurity percentage
 - (c) removal of foreign atoms
 - (d) increasing the bias potential
10. is an example of acceptor material.
 - (a) Gallium
 - (b) Arsenide
 - (c) Bismuth
 - (d) Antimony
11. Recombination of electrons and holes takes place when
 - (a) an electron falls into a hole
 - (b) a positive ion and a negative ion bond together
 - (c) avalanche electron becomes a conduction electron
 - (d) an atom is formed

12. The atomic number of silicon is
(a) 14 (b) 16
(c) 18 (d) 12
13. In a semiconductor, the total current is equal to
(a) sum of electron and hole currents flow in same direction
(b) sum of electron and hole currents flow in opposite directions
(c) electron current only
(d) hole current only
14. Germanium and silicon are
(a) trivalent (b) tetravalent
(c) pentavalent (d) covalent
15. The volume charge density of mobile carriers is expressed in
(a) coulombs / cubic meters
(b) coulombs / meters
(c) coulombs / seconds
(d) coulombs / volts
16. In a Silicon crystal, the number of covalent bonds a single atom can form is
(a) 2 (b) 4
(c) 6 (d) 8
17. The atomic number of germanium is
(a) 24 (b) 26
(c) 28 (d) 32
18. Which electron in an element is responsible for chemical & electrical properties ?
(a) valence electrons (b) revolving electrons
(c) active electrons (d) passive electrons
19. What does a Hall Effect sensor sense ?
(a) Temperature (b) Moisture
(c) Magnetic fields (d) Pressure
20. Which of the following doesn't have forbidden energy gap between valence band and conductor band ?
(a) conductor (b) insulator
(c) semiconductor (d) none of the above
21. While plotting the VI characteristics of semiconductor diode, the voltage is plotted along horizontal axis and the current along the vertical axis because
(a) The voltage and currents are independent variables
(b) The voltage and currents are dependent variable
(c) The voltage is dependent and the current is independent variable
(d) The voltage and the current are dependent variables
22. In a semiconductor diode, the time constant equals to
(a) Value of majority carrier lifetime
(b) Value of minority carrier lifetime
(c) Diffusion capacitance time constant
(d) Zero
23. As the temperature increases in a semiconductor, the densities of the electrons and holes
(a) Increase (b) Decrease
(c) Become equal (d) Can't be defined
24. Drift current in the semiconductors depends upon
(a) only the electric field
(b) only the carrier concentration gradient
(c) both the electric field and the carrier concentration
(d) both the electric field and the carrier concentration gradient
25. The conductivity of the intrinsic semiconductor at absolute temperature is
(a) 1.1 eV (b) 0.63 eV
(c) Zero (d) infinity
26. Diamond is a
(a) Conductor (b) Insulator
(c) Semiconductor (d) None of these
27. The Hall coefficient of an intrinsic semiconductor is
(a) Positive under all conditions
(b) Negative under all conditions
(c) Zero under all conditions
(d) Zero at 0°K